

LAYERED PLANTERS

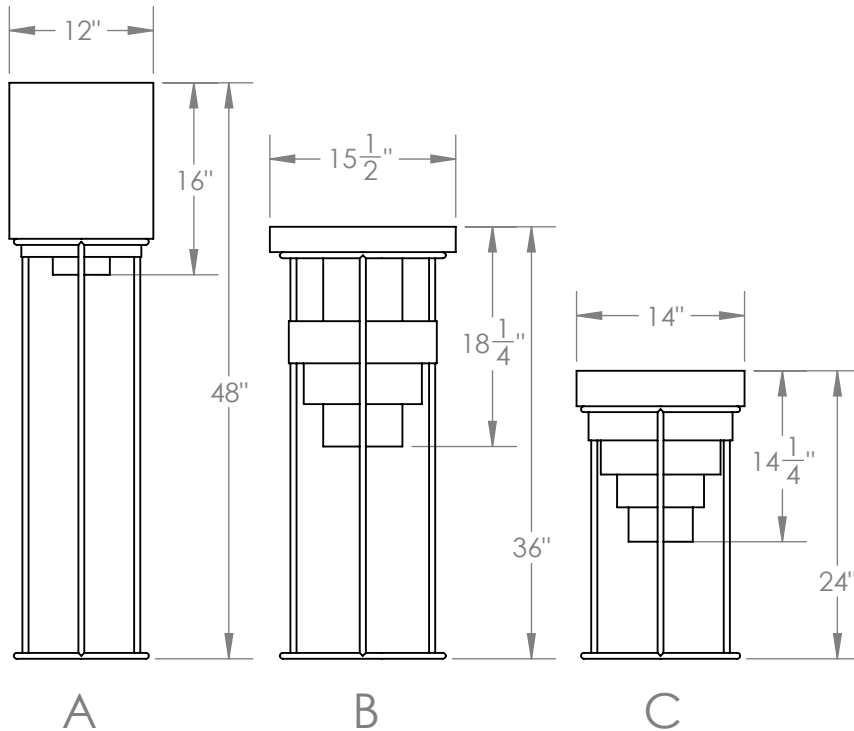

Our cold rolled stainless steel planters and steel bases are finished in a rich satin black and available in 3 different shapes.



Materials

Steel

Standard Finishes

Satin Black

Notes

Fill base with rocks to allow for proper draining.
Please specify custom height for planter stand, if desired.

Retail

\$2750

Lead Time

8 to 10 weeks

Customization

Available - please contact us.