

# SLUMP CHAISE

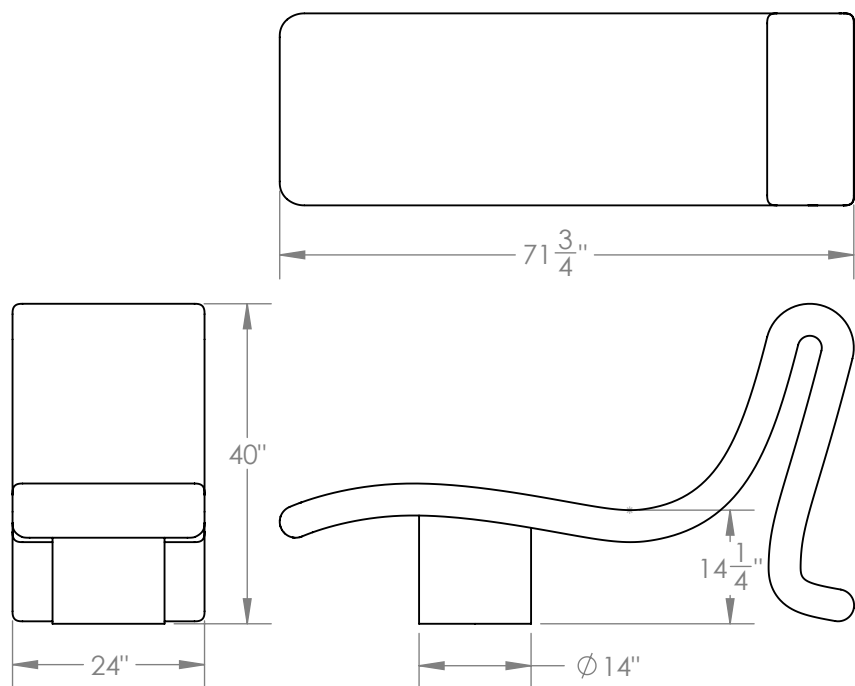

Made to work from every viewpoint, this wonderfully comfortable chaise combines maple burl with soft lines.



### Materials

Wood  
Cotton/Linen Blend

### Standard Finishes

Burl Veneer  
Cream Boucle

### Dimensions

24" W x 40" H x 71-<sup>3</sup>/<sub>4</sub>" D

### Notes

Available with COM fabric upon request.  
Please inquire for current veneer availability.

### Retail

\$19,250

### Lead Time

10-12 Weeks

**Customization** Available - please contact us. **Weight** ~55 lbs